

Assembly Instruction for





QUEEN STORAGE BED WITH LED (6-DRAWER)

280-3-B-QH / 280-3-B-QSF / 280-3-B-QSR 280-7-B-QH / 280-7-B-QSF / 280-7-B-QSR

⚠ WARNING: To avoid serious personal injury:







- Carefully and strictly follow assembly instructions. Improper assembly of furniture can result in structural failure, instability of the product, or tip-over.
- Monitor and carefully control the assembly components. These include small parts and hardware that may present a choking hazard to small children. Bob's furniture should be assembled only by responsible adults and children should not be involved in the assembly process.
- Where provided, wall mounting hardware should always be used as prescribed in these instructions to anchor furniture to walls. Proper use of the wall mounting hardware can significantly reduce the potential for furniture tip-over and crushing injuries.

PART LIST FOR HEADBOARD			
NO.	PART DESC	CODE.	Q'TY
A	Headboard	280-3-B-QH 280-7-B-QH	1
B	Left Headboard Leg	P280-3-B-HBLEGL P280-7-B-HBLEGL	1
C	Right Headboard Leg	P280-3-B-HBLEGR P280-7-B-HBLEGR	1
D	Headboard Bottom Stretchet	P280-3-B-QHSTR P280-7-B-QHSTR	1

HARDWARE LIST FOR HEADBOARD			
NO.	HARDWARE DESC	CODE.	Q'TY
1	 Allen bolt (Ø5/16" 1-3/4")	P280-B-KSRHW	8
2	 Spring washer (Ø5/16")		8
3	 Flat washer (Ø5/16" 3/4")		8
4	 Allen key (Ø1/8")		1









Headboard Hardware Packed with Headboard

PART LIST FOR FOOTBOARD			
NO.	PART DESC	CODE.	Q'TY
E	Footboard	280-3-B-QSF 280-7-B-QSF	1
F	Storage Footboard Drawer Slat	P280-B-QSFSLT	1
G	Storage Drawer Support Leg with Leveler	P280-3-B-SRSPL	1
H	Storage Drawer Support Rail with Glide	P280-3-B-BDSRL	2
I1	Drawer Front Panel	P280-3-B-KQRDRW P280-7-B-KQRDRW	2
I2	Drawer Back Panel		2
I3	Drawer Bottom Panel		2
Z	Drawer Side Panel		4
K	Queen Bed Slats	P280-B-QBSLT	13

HARDWARE LIST FOR FOOTBOARD			
NO.	HARDWARE DESC	CODE.	Q'TY
4	 Allen key (Ø1/8")	P280-B-KSRHW	1
5	 Allen bolt (Ø1/4" 1-1/4")		6
6	 Spring washer (Ø1/4")		2
7	 Flat washer (Ø1/4" 3/4")		2
8	 Allen bolt (Ø1/4" 13/16")		24
9	 Wood Screw (Ø4" 1")		30

Footboard Hardware Packed with Footboard

PART LIST FOR STORAGE RAILS			
NO.	PART DESC	CODE.	Q'TY
P1	Left Storage Rails	280-3-B-QSR 280-7-B-QSR	1
P2	Right Storage Rails		1
M	Roll-Slat Center Support Rail	P280-B-KQCRL	1
N	Short Slat Support Leg with Leveler	P280-B-BDSPL2	3
O	Long Slat Support Leg with Leveler	P280-B-BDSPL1	2
I1	Drawer Front Panel	P280-3-B-KQRDRW P280-7-B-KQRDRW	4
I2	Drawer Back Panel		4
I3	Drawer Bottom Panel		4
Z	Drawer Side Panel		8
J	Storage Side Rails Drawer Slat with Glide	P280-B-QSRSRL	2
G	Storage Drawer Support Leg with Leveler	P280-3-B-SRSPL	2

HARDWARE LIST FOR STORAGE RAILS			
NO.	HARDWARE DESC	CODE.	Q'TY
4	 Allen key (Ø1/8")	P280-B-KSRHW	1
5	 Allen bolt (Ø1/4" 1-1/4")		10
6	 Spring washer (Ø1/4")		2
7	 Flat washer (Ø1/4" 3/4")		2
8	 Allen bolt (Ø1/4" 13/16")		48
10	 Allen bolt (Ø5/16" 1")		12
11	 Spring washer (Ø5/16")		12
12	 Flat washer (Ø5/16" 3/4")		12

Storage rails Hardware Packed with Storage rails

⚠ Only tighten all bolts when all bolts aligned with bolt inserts.

Assembly Instruction for QUEEN STORAGE BED WITH LED (6-DRAWER)

280-3-B-QH / 280-3-B-QSF / 280-3-B-QSR
280-7-B-QH / 280-7-B-QSF / 280-7-B-QSR

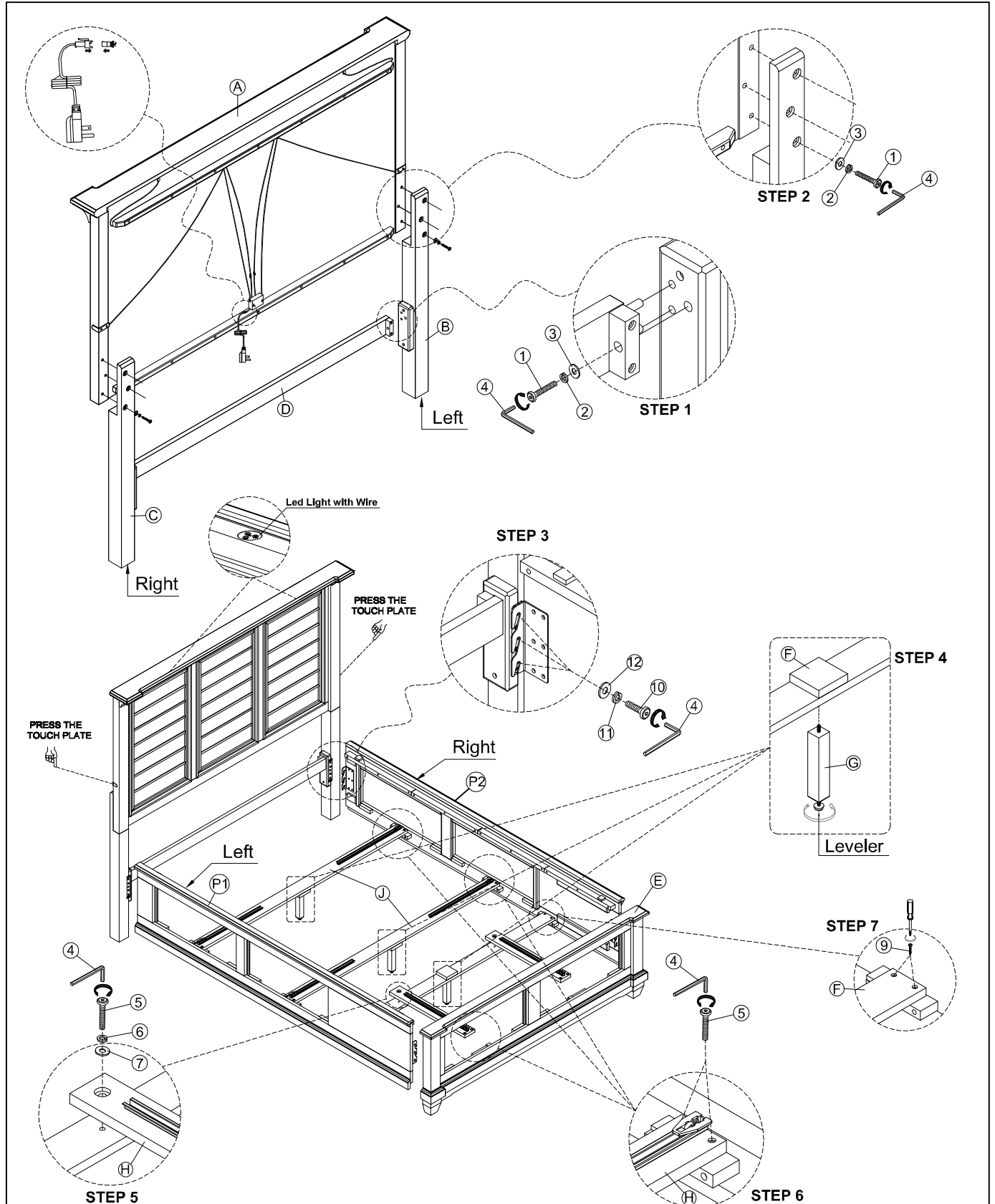

Assembly Instruction for QUEEN STORAGE BED WITH LED (6-DRAWER)

280-3-B-QH / 280-3-B-QSF / 280-3-B-QSR
280-7-B-QH / 280-7-B-QSF / 280-7-B-QSR

