

BOB'S

Discount Furniture®

ADJUSTABLE BED BASE POWER BOB ELITE/BB200 USER MANUAL



■ Please read the manual carefully and keep it safe for future maintenance.

Contents

| | |
|---------------------------------------|----|
| Safety & Warranty Warnings | 01 |
| Overview & Parts List | 03 |
| Installation Guide | 05 |
| Remote Control Instructions | 07 |
| Pairing Remote Control Instructions | 08 |
| Synchronizing Two Bases | 09 |
| Bluetooth Instructions | 10 |
| Emergency Battery Backup | 12 |
| Slat Stabilizer Assembly Instructions | 13 |
| Troubleshooting | 14 |

Safety & Warranty Warnings

ATTENTION:

Read the following information before using this product. Failure to use a surge protection device could compromise safety or cause product malfunction and could void the electrical portion of your warranty.

Electrical surges are by far the biggest cause of problems with electrical circuits. In order to help protect your investment in case of a power surge or outage, use an electrical surge protection device (not included).

WARRANTY WARNING!

Do not open or tamper with the transformer, control box, motors, or remote control (with the exception of battery compartments). The product warranty will be void if these components are tampered with.

SMALL CHILDREN AND PETS:

Immediately dispose of all packing materials as they can smother small children and pets. Do not allow any persons or pets under the bed. Children, convalescents and disabled person should not operate the bed without adult supervision.

HOSPITAL OR CONVALESCENT USE DISCLAIMER:

Adjustable beds are designed and engineered for a life style of in-home comfort and are not intended for hospital use or for a bed-ridden patient on an extended recovery. Adjustable beds are not equipped with bars to help patients get safely in and out of bed and are not intended to be used around tent type oxygen therapy or explosive gases.

PACEMAKER WARNING:

Electronics may activate a special sensor in your pacemaker that detects motion. This can fool the pacemaker into “thinking” you are engaged in some sort of physical activity and require a faster heart rate. You may experience a sensation similar to when you are exercising. Consult your physician for further information.

PRODUCT RATINGS:

The bed lift motors are not designed for continuous use of more than 2 minutes in an 18 minutes period, or approximately 10% duty cycle. Any attempt to circumvent or exceed this rating will shorten the life expectancy of the product and may void the warranty.

WEIGHT LIMITS:

The limitation for this adjustable bed is 850 lbs. The bed will structurally support these weights, provided weight is evenly distributed across the head and foot sections. This product is not designed to support or lift this amount in the head or foot section alone. Exceeding this weight restriction could damage the bed and/or cause injury and void the warranty. Enter or exit the bed in a flat position and do not sit on the head or foot sections while in the raised position.

Safety & Warranty Warnings

LIFTING AND LOWERING MECHANISMS AND MASSAGE UNITS:

It is normal for the raising and lowering feature on this bed to emit a minimal humming sound during operation. The massage feature creates a vibrating hum during operation and the resonance will increase accordingly with a higher intensity motor setting.

LOCATION ENVIRONMENT:

The level of sound experienced in a room is directly related to the environment within that location. In a room with hardwood floors and the massage units turned on, a vibrating noise can be noticeable. To reduce the resonance, place a piece of carpet or rubber casters cups under the legs. The rubber caster cups also prevent the bed sliding when located on smooth or hard surface flooring.

TO REDUCE THE RISK OF SHOCK, BURNS, FIRE OR INJURY:

Make sure the base is in a flat position and the vibrating motors are turned off before unplugging the bed base from the power source. Always unplug the base from the electrical outlet before cleaning or servicing the base. If the cord or plug is damaged, discontinue use of the bed base. Contact a qualified service personnel for examination and repair.

FCC COMPLIANCE:

This device complies with part 15 of the FCC Rules for residential use. Operation is subject to the following two conditions: (1) This device may not cause harmful interference, and (2) this device must accept any interference received, including interference that may cause undesired operation.

Note: This equipment has been tested and found to comply with the limits for a Class B digital device, pursuant to part 15 of the FCC Rules. These limits are designed to provide reasonable protection against harmful interference in a residential installation. This equipment generates, uses and can radiate radio frequency energy and, if not installed and used in accordance with the instructions, may cause harmful interference to radio communications. However, there is no guarantee that interference will not occur in a particular installation. If this equipment does cause harmful interference to radio or television reception, which can be determined by turning the equipment off and on, the user is encouraged to try to correct the interference by one or more of the following measures:

- Reorient or relocate the receiving antenna.
- Increase the separation between the equipment and receiver.
- Connect the equipment into an outlet on a circuit different from that to which the receiver is connected.
- Consult the dealer or an experienced radio/TV technician for help.

Radio Frequency: 2.4 GHz

For customer service under this limited warranty please contact Nisco.

Toll free phone: **1.855.430.8943**

POWER BOB ELITE/BB200 Overview & Parts List

All electronics and components that need to be installed are located in boxes.
Before discarding the packing materials, ensure that all the parts are accounted for.

A



AAA Batteries (3) & Remote Control (1)

B



3"+3"+3"+3" Bed Legs
with Washers (6)

C



Power Supply (1)

D



Power Cord (1)

E



Splitter Cable (1)
(Included With TXL Size ONLY)

F

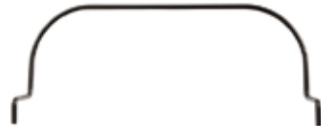

Retainer Bar (1)
2pcs for Cal King/King sizes only
Attached To The Bed Frame

POWER BOB ELITE/BB200 Overview & Parts List

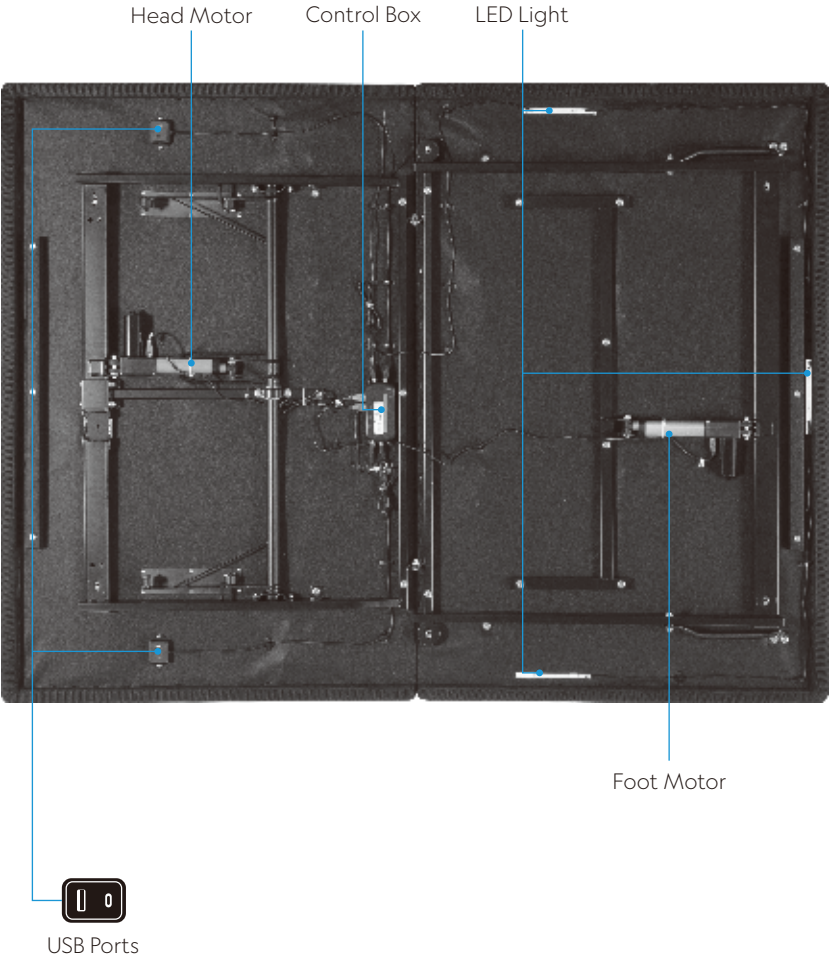

Installation Guide

Notes

1.



Two people are required to assemble this adjustable base.

2.



Open the carton in the flat position, bottom facing up, to avoid damage.

Step 1

Remove folded bed base from the box and carefully unfold it top side down on the floor.



Use caution to avoid pinning fingers or any underside wires along the hinge.

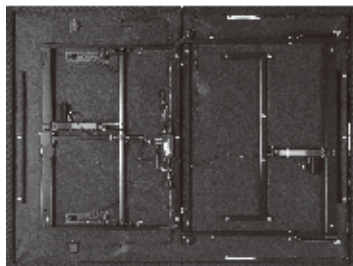

Step 2

Open the accessories box and ensure all accessories are included (see page 03).

Attaching Bed Legs

Step 1

The bed legs come in four segments (3", 3", 3" and 3"). These segments can be combined to achieve different heights, allowing you to adjust the base to match your bed frame.

Add Leg Washer between leg and bed frame and then hand tighten the legs by threading them clockwise into the prethreaded holes on the bed frame.



Nut on the frame is removable and replaceable. Please remove tape on the nut to install legs.

Step 2

Once legs are attached, please pick up from head and foot and flip without resting on legs.

Installation Guide

Installing Retainer Bar

Step 1

With assistance turn the bed frame over, top side up.

Step 2

Insert the ends of the retainer bar into the quick connect brackets located at the foot of the bed.



Setting Up Electronics

Step 1

Take out the power supply and power cord from the accessory box.



Step 2

Connect the power cord and plug the power cord into a working electrical outlet.



Note: Do not overload power board.

Step 3

Install the three (3) AAA batteries into the remote control. Confirm the remote control works by pressing the lift buttons.

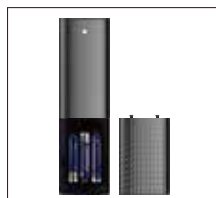

POWER BOB ELITE/BB200 Remote Control Instructions

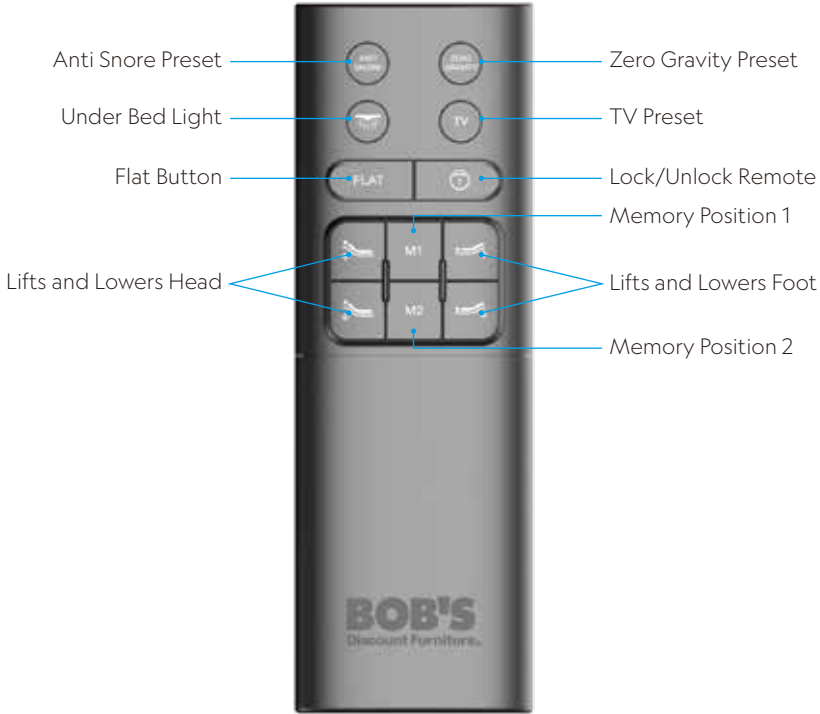

🔒 LOCK: Press and hold the button for three (3) seconds, when the backlight on the remote flashes, the lock is completed. If any button is pressed while under the lock status, the backlight on the remote will flash.

UNLOCK: Press the button for three (3) seconds. when the backlight on the remote flashes, the unlock is completed and the remote will operate normally.

Pairing Remote Control Instructions

The original remote that comes in the box should already pair with the base. In the event that the remote is not paired with the base, follow these steps.

Remote Is Not Paired With The Base

STEP 1

Make sure the batteries in remote work fine. Replace them when necessary.

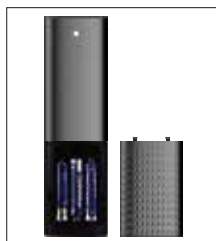

STEP 2

Plug the power cord to the power source.



STEP 3

Press & hold buttons of head up and foot up simultaneously, and then press & hold the pair button on the cord that connected to the power supply. Once you hear beeps, it is paired.



Synchronizing Two Bases

Using the Sync Cable

Two TXL bases may be placed next to each other to form a King. Both sides can be operated independently with their own remotes, or if desired, a single remote can be used with both bases. Using a single remote for both bases will result in the bases moving jointly.

Setting Up Electronics

Step 1

Ensure both bases (A & B) are plugged into a power source and both in the flat position.

Step 2

Using the splitter cable (included with TXL base only) plug both cables into each base's control box. The bases should now be controlled by one remote.



Bluetooth Instructions

STEP 1

Plug base into power source.

STEP 2

Turn Bluetooth on in cell phone.

STEP 3

Install the APP.

Option 1)

Go to APP Store (IOS SYSTEM) / Google Store (ANDROID SYSTEM)

Type "POWER BOB BASE" into search field and select APP, press "install" to install APP onto cell phone as shown below.



Option 2)

Scan this QR code to APP stores for download.



STEP 4

Control device via "POWER BOB BASE" APP.

1) Open "POWER BOB BASE" APP that was previously installed on cell phone as shown in picture below.



Bluetooth Instructions

2) Open app that was previously installed on cell phone as shown in picture below. Select bed type first and then name your bed, third, select your bed model, last, pair your bed by selecting the QR code on bed frame (you can find it on the head frame or control box).

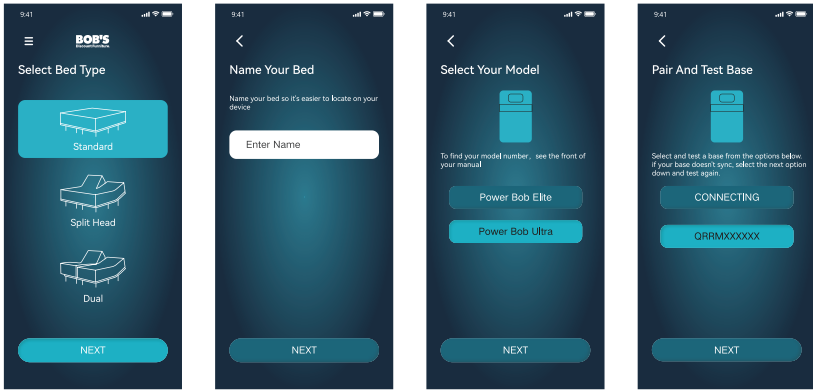

3) Open control center and select desired options.

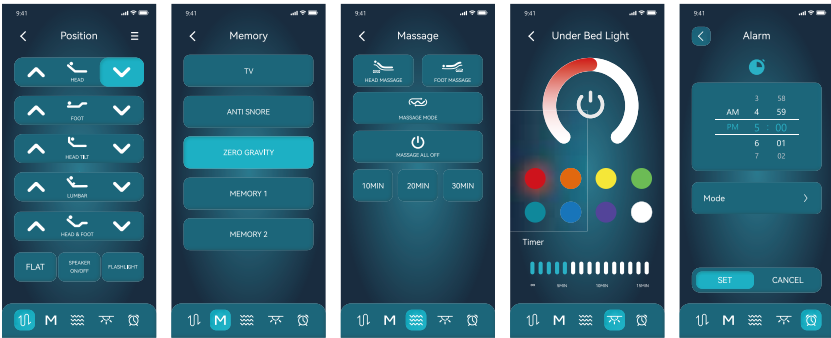

Emergency Battery Backup

Overview

Important: The backup battery is only to be used in case of a power outage. Batteries are not to be used for normal operation of the bed. The backup battery will not support repeated movement for an extended period of time.

Backup Battery Use:

Use two 9V batteries only (not included). If a power outage occurs, install the 9V batteries into the power supply to allow temporary power to the base (see image A).

Installing Batteries:

Unplug the power cord from the outlet and remove the cover from the compartment on the underside of the power supply (see image B). Place two 9V batteries inside, close the cover and plug the power cord back into the wall outlet. The backup battery will not support repeated movement for extended periods of time. After power is restored, unplug power cord, remove the batteries, then plug the power cord back into the wall for normal use.

A





B



Slat Stabilizer Assembly Instructions

Parts List:

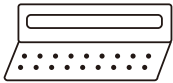
| | | | |
|---|---|---|---|
|  |  |  |  |
| (A) Bolts X4 | (B) Nuts X4 | (C) Screws X8 | (D) Brackets X2 |

NOTE:

Slat stabilizers are only needed if placing your adjustable base on a wooden platform without the legs.

Step 1

Prepare for installation by raising the head panel to access the frame and slats.

Step 2

Using two (A) bolts and two (B) nuts, attach one (D) bracket to the side of the adjustable base. Repeat on the other side.

Step 3

Using four (C) screws, attach the (D) bracket to the slats. Repeat on the other side.

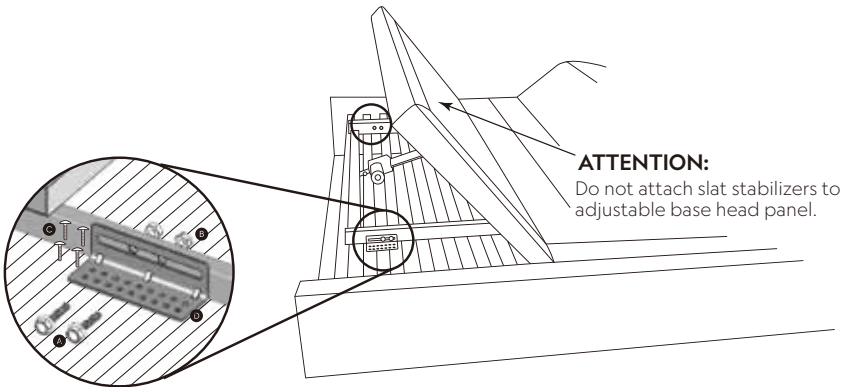

Read all instructions before assembling the adjustable base slat stabilizers. Before each usage or assembly, inspect the adjustable base for damaged hardware or missing parts. DO NOT use the adjustable base if any parts are missing or broken. If replacement parts and instructional literature are needed, contact the manufacturer at **1.855.430.8943**, DO NOT substitute parts.

Troubleshooting

In the event that the power foundation fails to operate, assess the symptoms and possible solutions provided in the chart below.

Remote control illuminates and appears to be operable, but will not activate bed.

Verify that the power cord is plugged into a working, grounded electrical outlet. Test the outlet by plugging in another working appliance.

No features of the power will activate.

Program the remote control (see the Setting Programmable Positions and Pairing Remote section of this manual for programming procedures).
Unplug the power cord, wait 30 seconds and plug back to reset electronic components. The surge protection device or the electrical outlet may be defective. Test the outlet by plugging in another working appliance.

Wireless remote will not illuminate.

Replace the batteries in the wireless remote.

Head or foot section will elevate, but will not return to the horizontal (flat) position.

Bed mechanism may be obstructed. Elevate bed and check for obstruction. Remove obstruction.
Head section may be too close to the wall. Headboard may be too close to the edge of the mattress. Verify that there is enough distance between the headboard brackets and mattress. Adjust if required.

Troubleshooting

Head & Foot lift function has minor interference during operation.

Check batteries in wireless remote control, replace with three (3) new AAA batteries if necessary.

Make sure that you are following the duty cycle of the motors (do not operate more than two minutes over an 18-minute period, or approximately 10% duty cycle).

Press the lift buttons squarely and accurately. Wireless remote control may be experiencing common Radio Frequency Interference from other radio transmitting devices. Wait several seconds, and then try pressing the appropriate button again. See the FCC Compliance Statement on page 2 of this guide.

A clicking noise is heard under the bed when raising or lowering.

This is normal. The lift motor relays “click” when they are engaged. No action is required.

BOB'S

Discount Furniture®

Contact US

We're here to help you.

If you have any issues with this product, please don't hesitate to reach out to us via email .

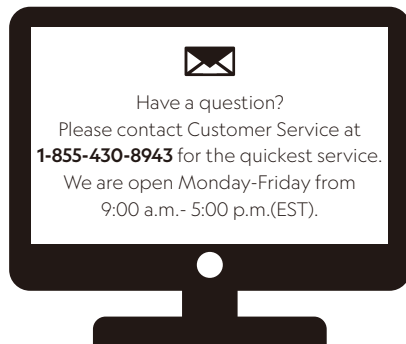

We want you to be completely satisfied with your purchase!

If anything is missing, damaged, incorrect, or not what you expected, don't worry.

Please keep the outer packaging and take photos of the packaging and products, then reach out to us at **niscustomerservicewest@gmail.com**.

We assure you that we will address your concerns and provide a solution within 24 hours.
