

 **WARNING: To avoid serious personal injury:**

- Carefully and strictly follow assembly instructions. Improper assembly of furniture can result in structural failure, instability of the product, or tip-over.
- Monitor and carefully control the assembly components. These include small parts and hardware that may present a choking hazard to small children. Bob's furniture should be assembled only by responsible adults and children should not be involved in the assembly process.
- Where provided, wall mounting hardware should always be used as prescribed in these instructions to anchor furniture to wall. Proper use of the wall mounting hardware can significantly reduce the potential for furniture tip-over and crushing injuries.

Installation Instruction

PARTS LIST:

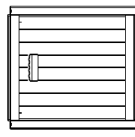
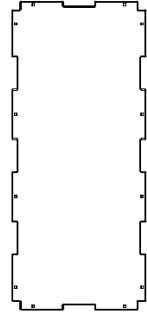
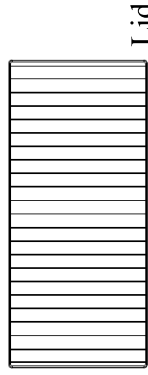
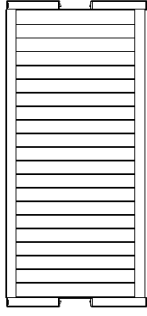
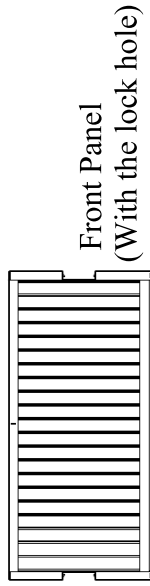

Step 1: Fix the front & back panels onto the bottom panel.

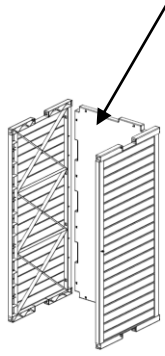

! Tip: Put the flat face upwards.

Step 2: Fix the side panels with the bottom, front & back panels.

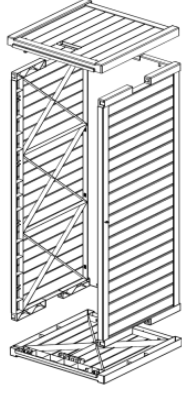

Step 3: Fix the lid with back panel using four hooks.

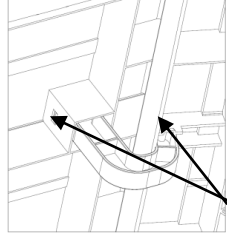
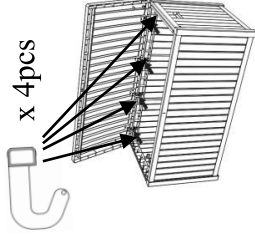

! Tip: Fix the four hooks with the back panel first by clicking in the holes, then click the hooks with the lid holes.

Step 4: Fix the HGSL(Right) and HGSL(Left) with screws to lid and side panels.

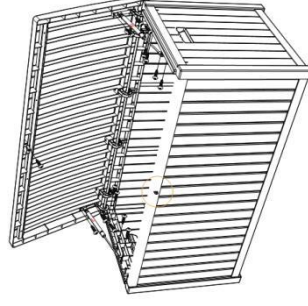
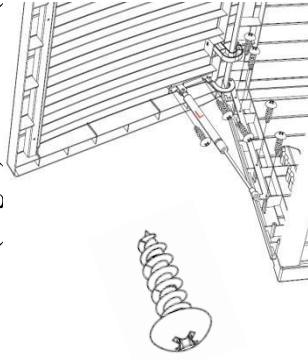

Step 5: Fix the lock A with Lid and Lock B with front panel as shown in the figure.

