

VIDEO

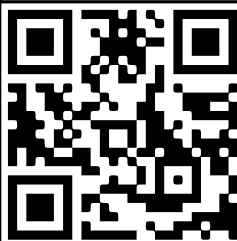

Scan QR to view full assembly video

Midback Mesh Task Office Chair

ASSEMBLY INSTRUCTIONS

REV.9-GLDP-8792-0325









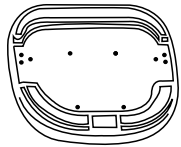

Thank you for purchasing our product!

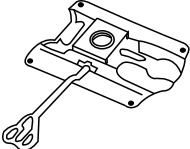

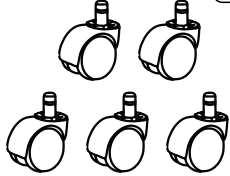
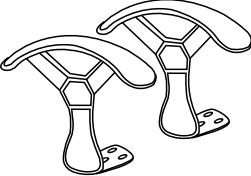
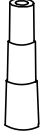
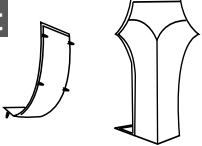
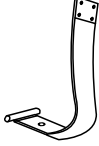
Do a quick inventory of all the parts and hardware listed below.

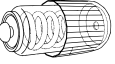

MAIN PARTS LIST

| | | | | |
|--|---|---|--|---|
| A Backrest  | B Seat  | C Nylon star base  | D Mechanism  | E Lift cylinder  |
| F Casters x5  | G Armrests x2  | H Covers for lift cylinder x1 Set  | I-C Covers for backrest x1 Set  | I-S Support for backrest x1 Set  |

| HARDWARE LIST | | | |
|---------------|-------|------------------|---|
| Part # | QTY | SIZE/Description | Item |
| J | 1 Set | Locking Pin |  mm 10 20 30 40 50 60 |
| K | 1 Set | Spring knob |  ≈ 110mm |
| L | 4 | M6x20 |  mm 10 20 30 40 50 60 |
| M | 4 | M6x25 |  mm 10 20 30 40 50 60 |

| HARDWARE LIST | | | |
|---------------|-----|------------------|---|
| Part # | QTY | SIZE/Description | Item |
| N | 6 | M6x30 |  mm 10 20 30 40 50 60 |
| O | 2 | ST3.5x16 |  mm 10 20 30 40 50 60 |

INCLUDED TOOLS

M5 Allen Wrench 

TOOLS NOT INCLUDED

Phillips screwdriver  ❌

ASSEMBLY STEPS

STEP 1

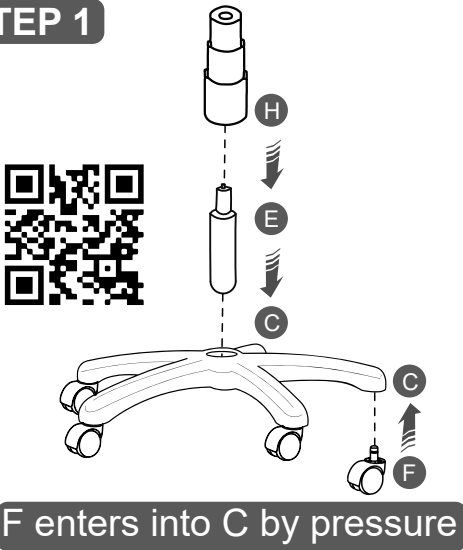

STEP 2

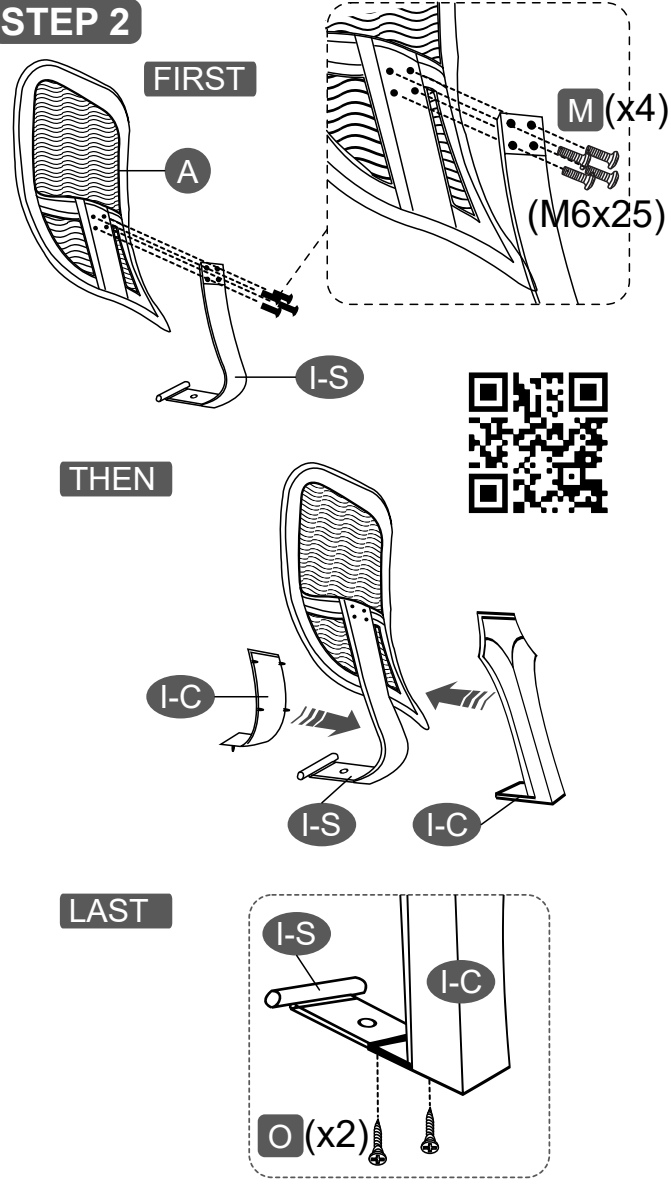

STEP 3

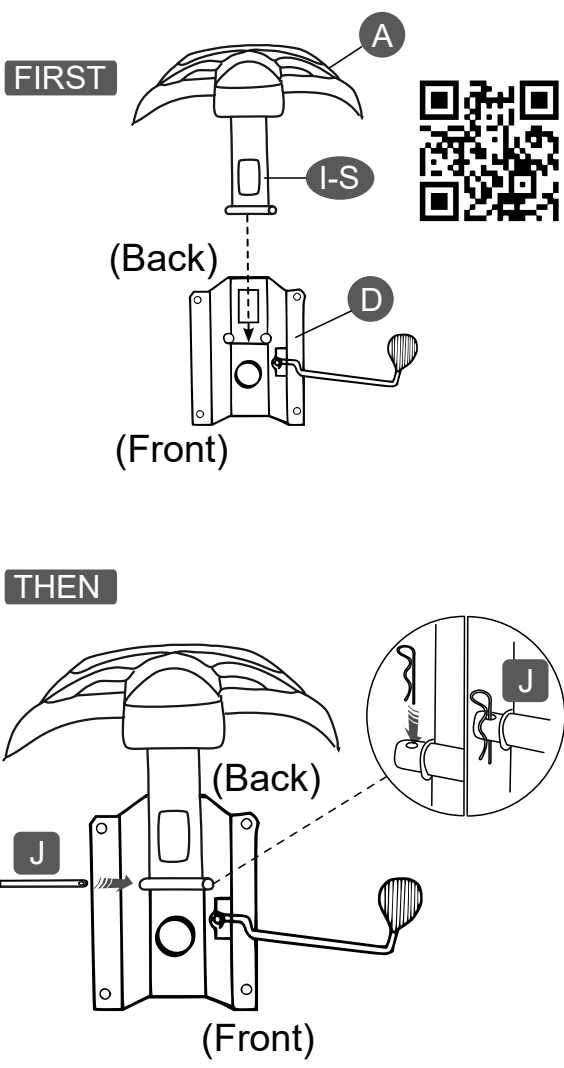

STEP 4 PAY ATTENTION!

Dissassemble K but keep all parts arranged in the order shown!

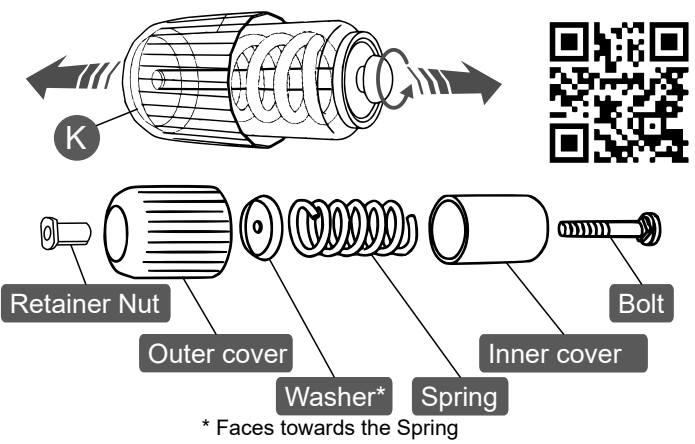

ASSEMBLY STEPS

STEP 5 PAY ATTENTION!

*** WARNING: VERY IMPORTANT!**

The washer MUST GO ABOVE the spring and facing TOWARDS it. The washer prevents the spring from popping out even if the outer cover breaks, keeping you secure in your chair.

RE-ATTACH IN THE EXACT ORDER SHOWN!

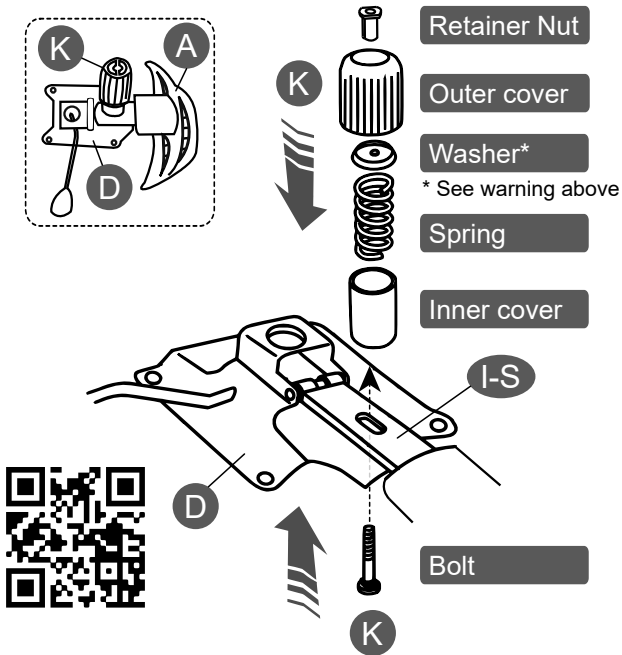

STEP 6

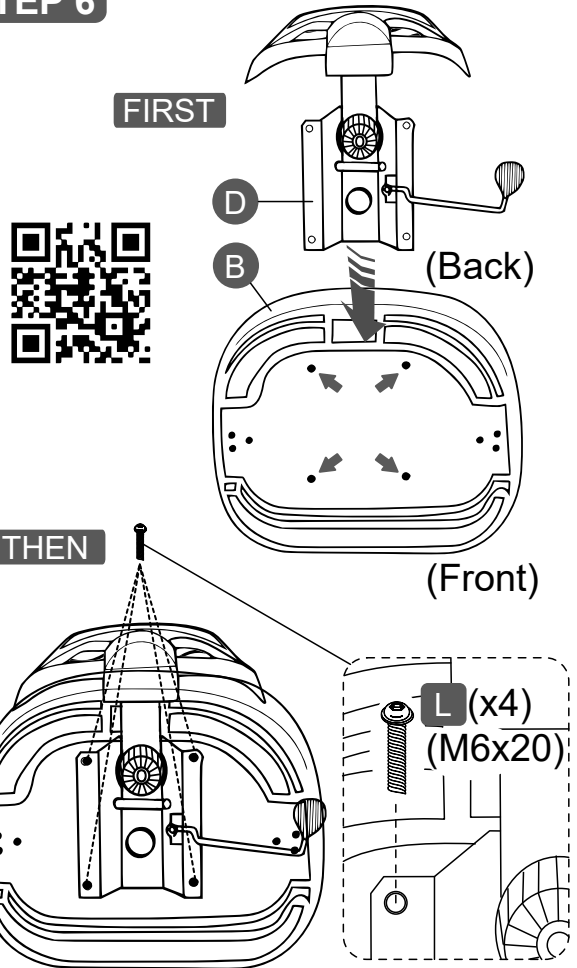

STEP 7

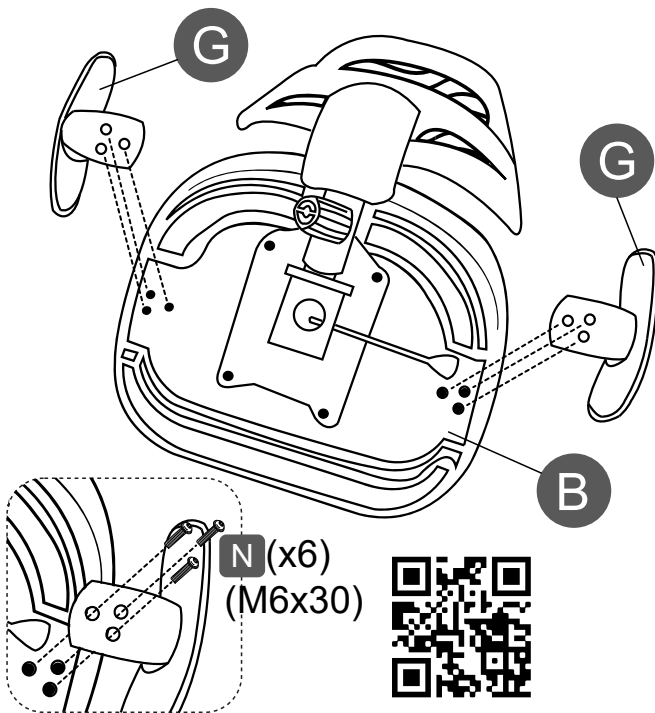

STEP 8

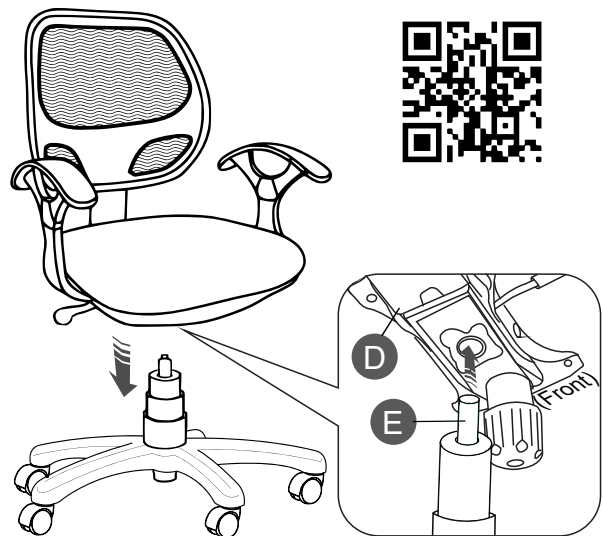

ALL DONE!

Please read all the warnings and tips on the next page, and enjoy your new chair!

CHAIR'S FUNCTIONS

Pull Handle UP.

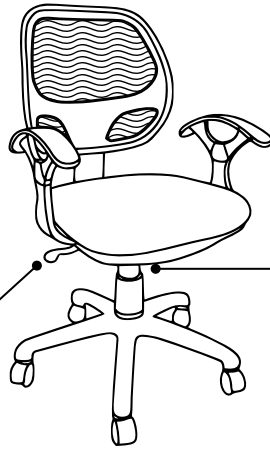
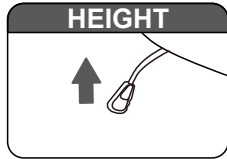

Do not loosen up too much!

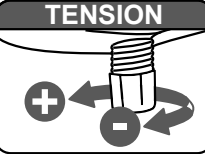
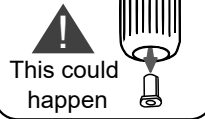

Turn **CLOCKWISE** for less tension (-); **COUNTERCLOCKWISE** for more tension (+).
With less tension, the tilting feels easier.

WARNINGS - Not paying attention to the following warnings could result in injuries.

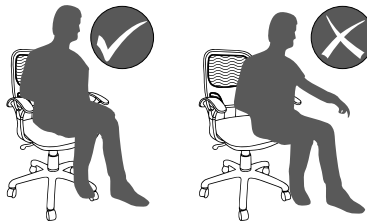
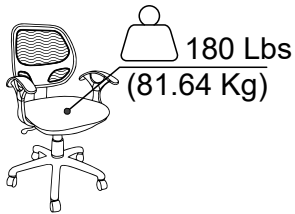

Only one person at a time and refrain from sitting on the edge of the seat to prevent the chair from tipping over.

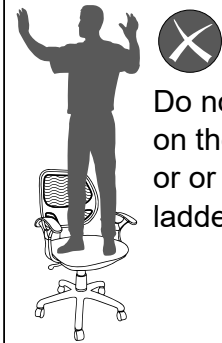

Do not stand on the chair or use it as ladder.

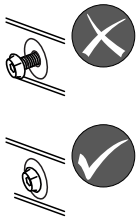

Do not use the chair if the frame parts are damaged, or if any of the screws are loose or missing.



Do not leave babies or toddlers unattended while seated on the chair, always ensure adult supervision. Keep children from playing with the chair for their safety.

CARE AND MAINTENANCE

Clean with a soft cloth lightly damped in a solution of smooth soap and water.

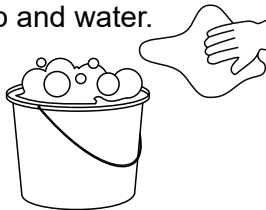

Do not use solvents or abrasive materials.



Do not expose to direct sunlight or to extreme environmental conditions.

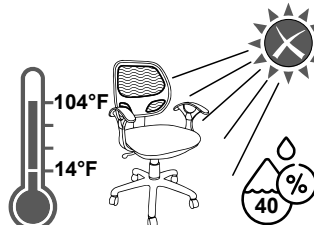

Inspect the chair thoroughly every 4 months and re-tighten the screws.

