

ASSEMBLY INSTRUCTIONS



! WARNING: To avoid serious personal injury:

- Carefully and strictly follow assembly instructions. Improper assembly of furniture can result in structural failure, instability of the product, or tip-over.
- Monitor and carefully control the assembly components. These include small parts and hardware that may present a choking hazard to small children. Bob's furniture should be assembled only by responsible adults and children should not be involved in the assembly process.
- Where provided, wall mounting hardware should always be used as prescribed in these instructions to anchor furniture to wall. Proper use of the wall mounting hardware can significantly reduce the potential for furniture tip-over and crushing injuries.

PARTS

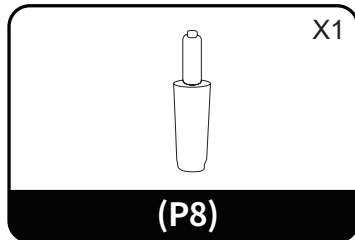
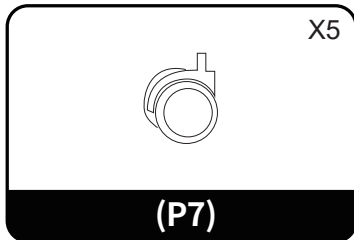
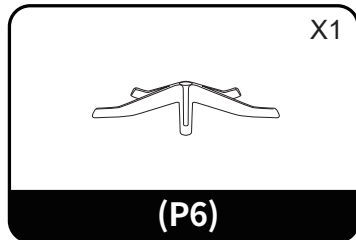
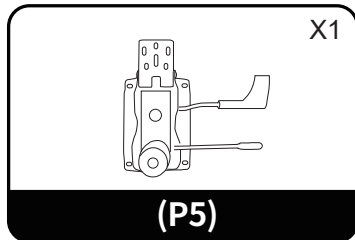
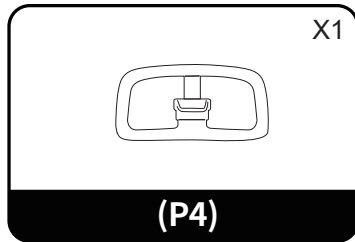
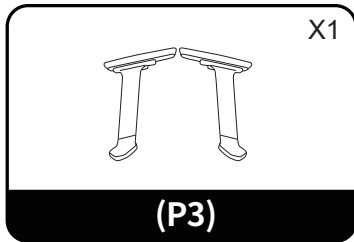
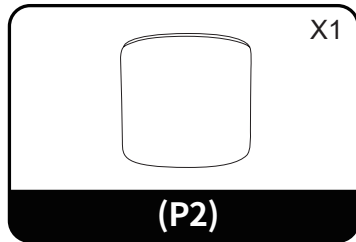
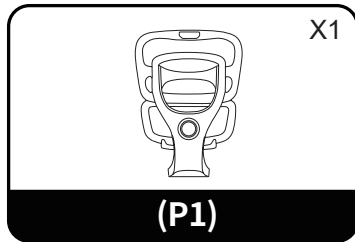

HARDWARE

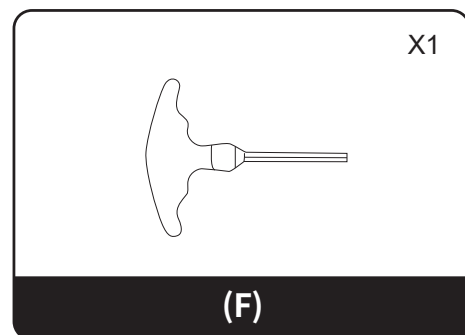
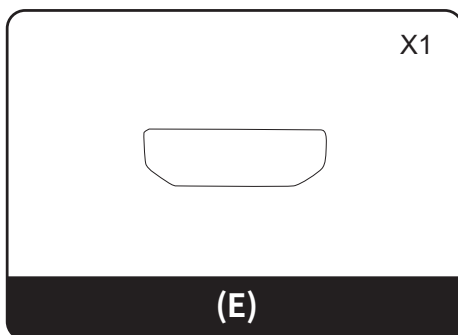
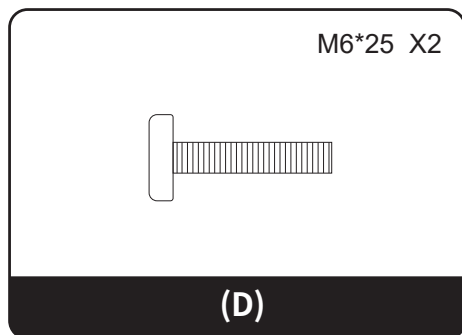
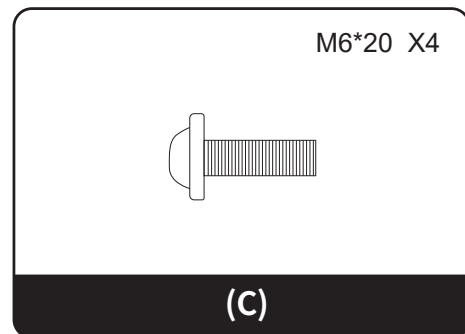
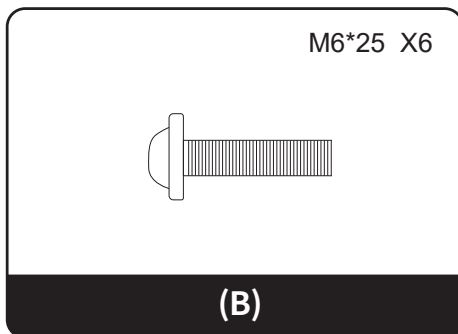
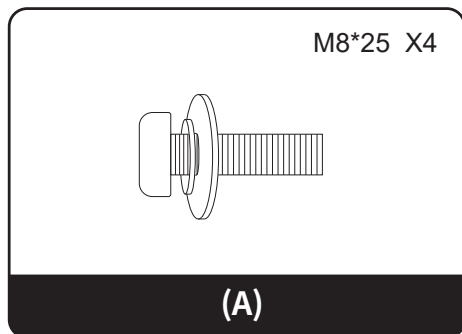



Do not tighten the screws until all of them are screwed into the holes.

ASSEMBLY INSTRUCTIONS

STEP 1

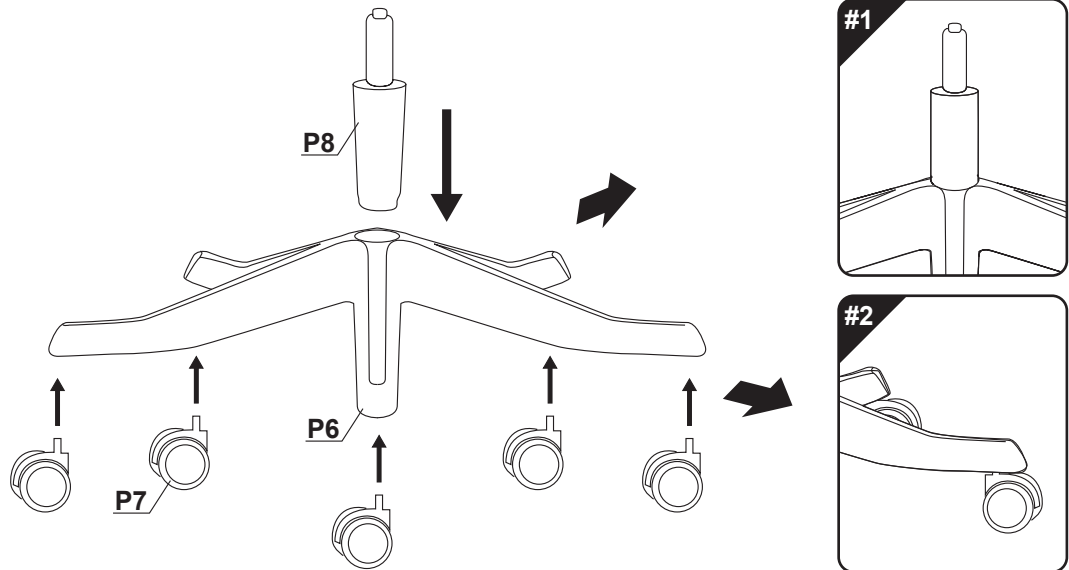
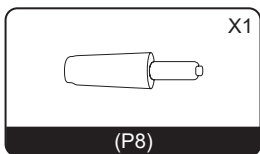
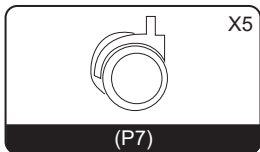
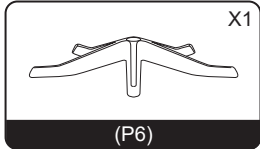

STEP 2

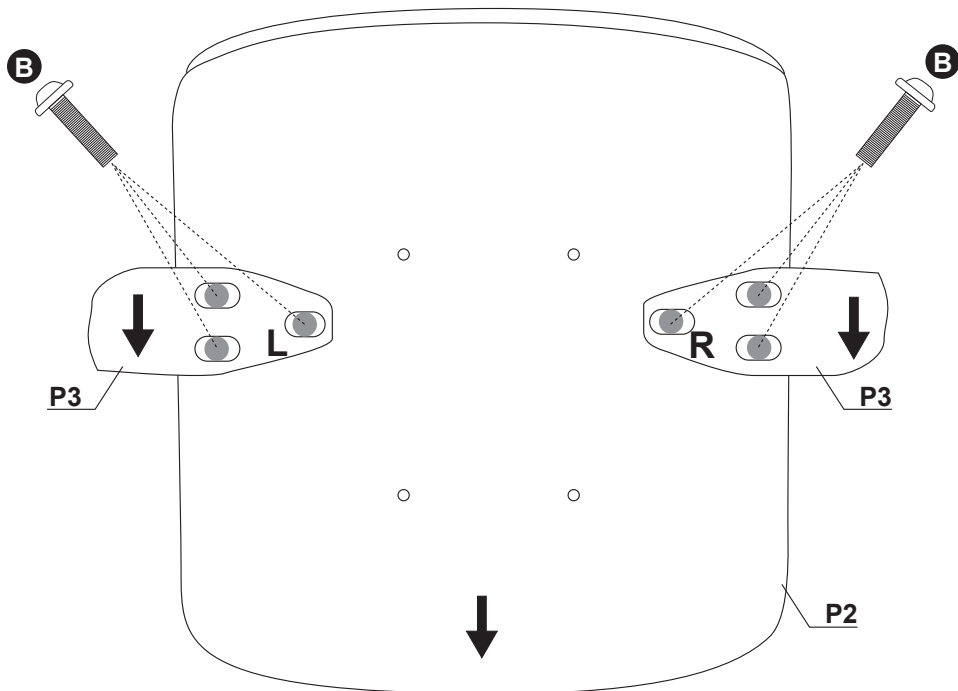
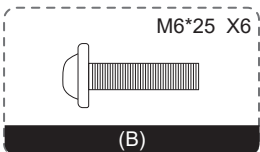
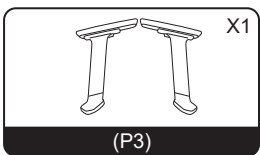
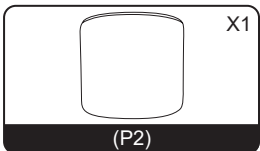

STEP 3

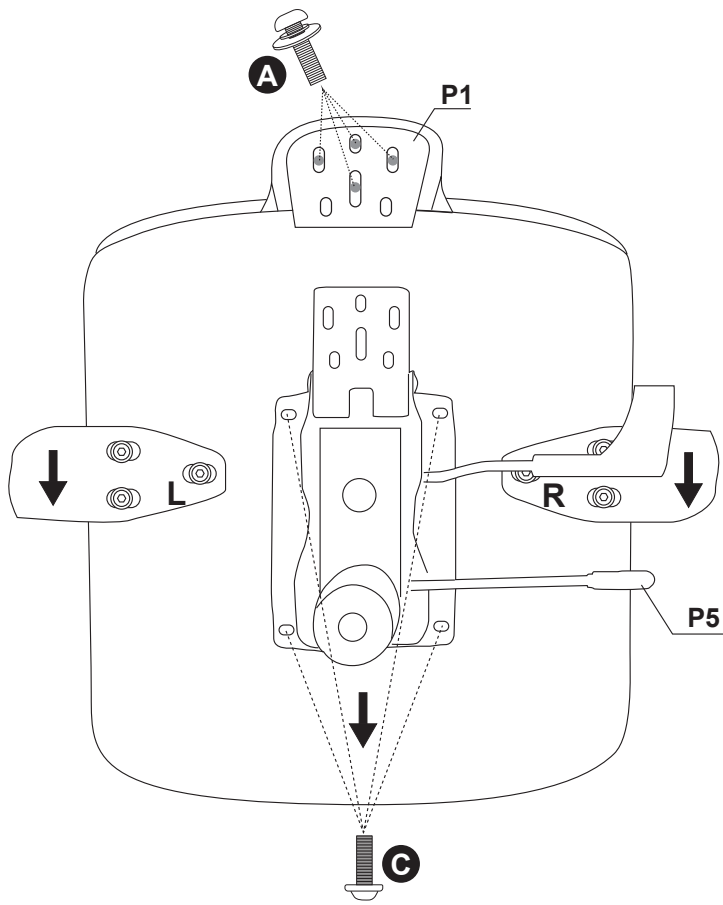
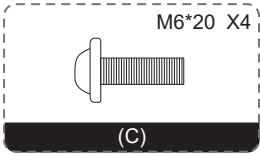
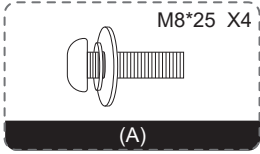
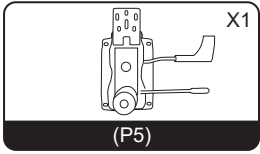
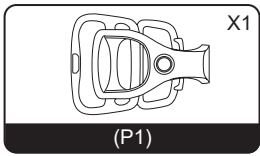

STEP 4

