





⚠ WARNING: To avoid serious personal injury:

- Carefully and strictly follow assembly instructions. Improper assembly of furniture can result in structural failure, instability of the product, or tip-over.
- Monitor and carefully control the assembly components. These include small parts and hardware that may present a choking hazard to small children. Bob's furniture should be assembled only by responsible adults and children should not be involved in the assembly process.
- Where provided, wall mounting hardware should always be used as prescribed in these instructions to anchor furniture to walls. Proper use of the wall mounting hardware can significantly reduce the potential for furniture tip-over and crushing injuries.

PART LIST FOR CASCADE ARMOIRE

NO.	PART DESC	CODE	Q'TY
A	 CASCADE ARMOIRE		1

HARDWARE LIST FOR CASCADE ARMOIRE

NO.	HARDWARE DESC	CODE	Q'TY
1	 HANDLE		2
2	 HANDLE BOLT(5/32"x1")		4
3	 ANTI-TIP KIT - METAL (SET)	P-ATKNCT-M	1
	 SCREW-DRIVER (NOT PROVIDED)		

⚠ Only tighten all bolts when all bolts aligned with bolt inserts

STEP 1

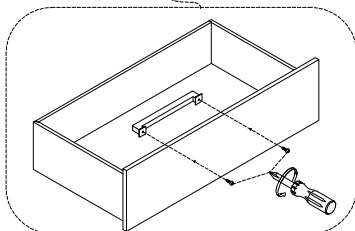
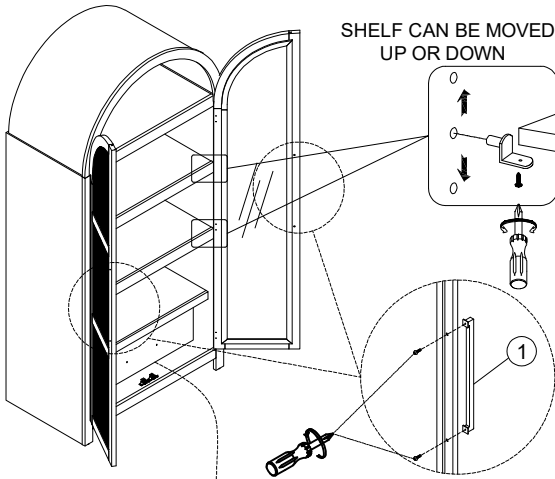

REMOVE HANDLE FROM INSIDE DRAWER



REATTACH HANDLE TO OUTSIDE OF DRAWER

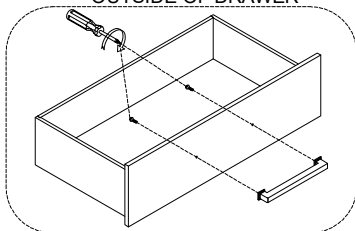

STEP 2

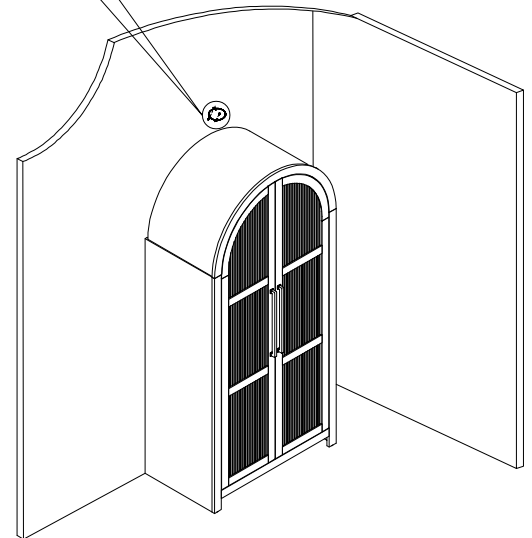
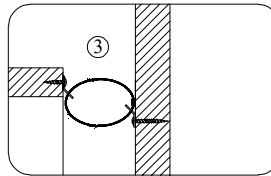

STEP 3

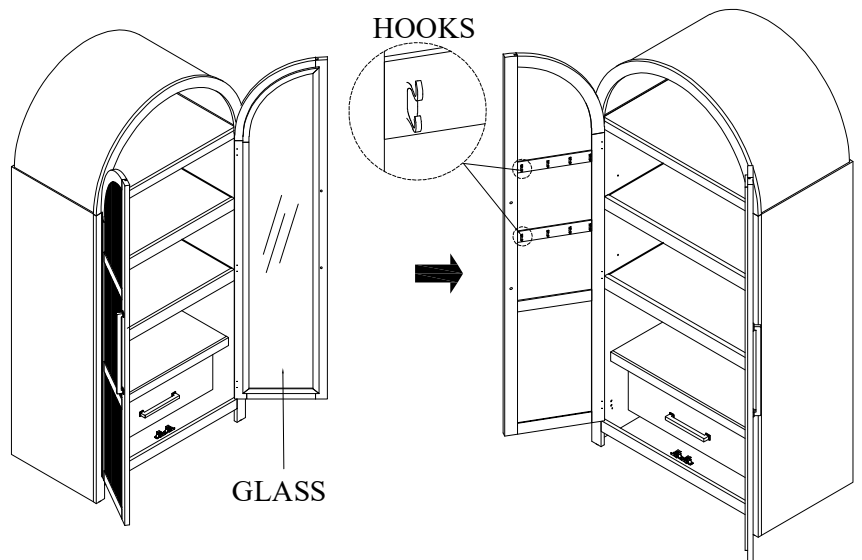

COMPLETED

