

ASSEMBLY INSTRUCTION







BOB'S SKU#: 20083157002/20083157001/20083157010

DESCRIPTION: KING HEADBOARD/FOOTBOARD/SIDE RAILS

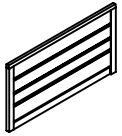

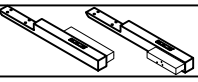

Thank you for purchasing this quality product. Be sure to check all packing material carefully for small hardware which may have come loose inside the carton during shipment. Identify and count all hardware and compare with the hardware list below.

TOOL REQUIRED (NOT PROVIDED):
PHILLIPS SCREW DRIVER 

HEADBOARD BOX

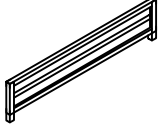
| NO. | Description | | | Q'ty | NO. | Description | Picture | Q'ty |
|-----|---|-------------|--------------|--------|-----|----------------------------|---|------|
| 1 |  | Allen bolt | Ø1/4"*45mm | 10sets | A | Headboard Panel |  | 1pc |
| |  | Lock washer | Ø1/4"*11*2mm | | | | | |
| |  | Flat washer | Ø1/4"*16*2mm | | | | | |
| 2 |  | Allen Key | 4*74*29mm | 1pc | B | Headboard Legs (L&R) |  | 2pcs |
| | | | | | C | Headboard Bottom Stretcher |  | 1pc |

FOOTBOARD BOX

| NO. | Description | | | Q'ty | NO. | Description | Picture | Q'ty |
|-----|---|------------|-----------|-------|-----|---------------------|---|-------|
| 4 |  | Allen bolt | Ø8*30mm | 10pcs | D | Footboard Panel |  | 1pc |
| 2 |  | Allen Key | 4*74*29mm | 1pc | | | | |
| | | | | | E | Bed Slat |  | 5pcs |
| | | | | | F | Center Support Legs |  | 10pcs |

SIDE RAILS BOX

| NO. | Description | | | Q'ty | NO. | Description | Picture | Q'ty |
|-----|-------------|--|--|------|-----|-------------|---|------|
| | | | | | G | Side Rails |  | 2pcs |

ASSEMBLY INSTRUCTION

BOB'S SKU#: 20083157002/20083157001/20083157010

DESCRIPTION: KING HEADBOARD/FOOTBOARD/SIDE RAILS

Thank you for purchasing this quality product. Be sure to check all packing material carefully for small hardware which may have come loose inside the carton during shipment. Identify and count all hardware and compare with the hardware list below.

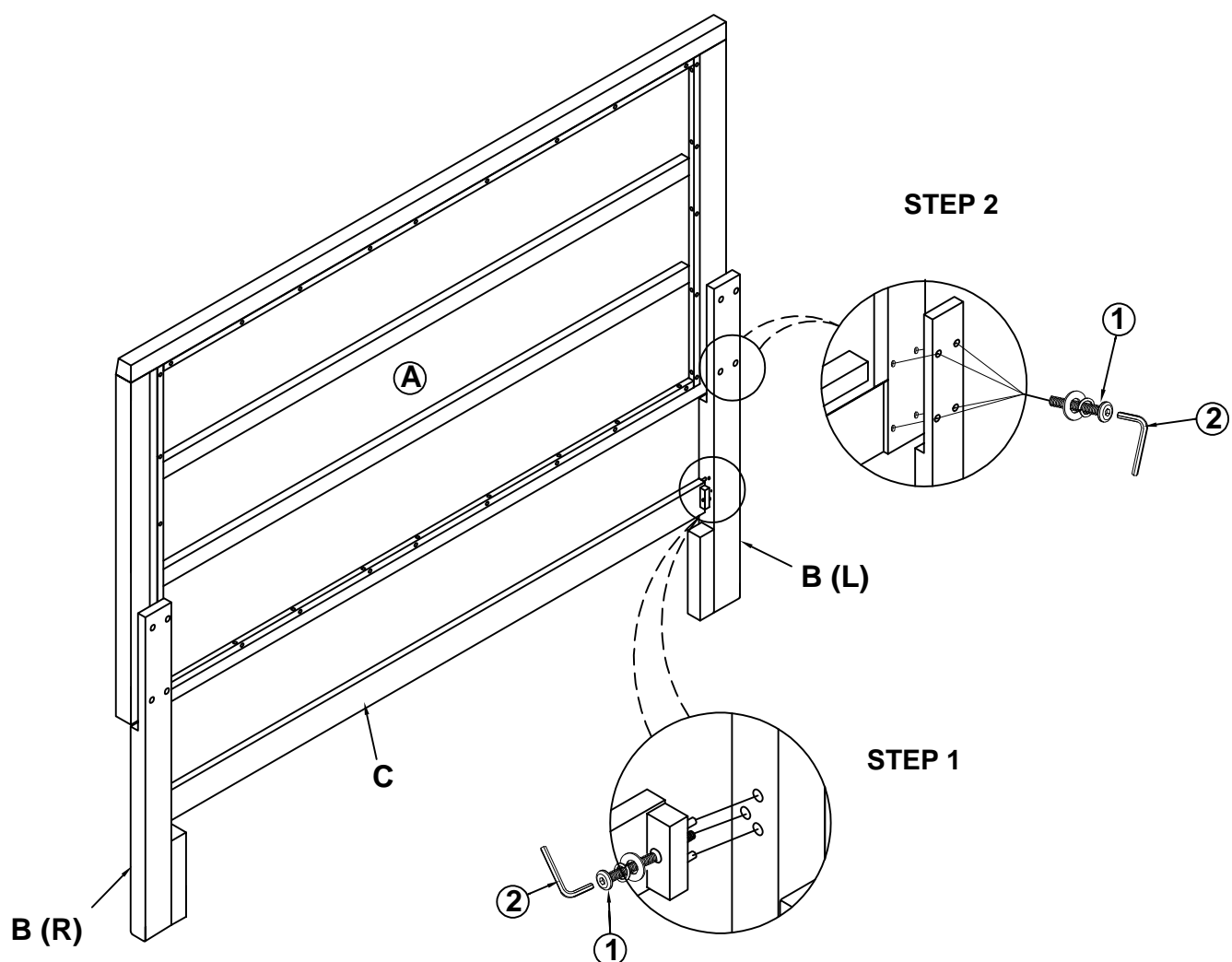

STEP 1: Attach crossbar (C) to headboard post left (B-L) and headboard post right (B-R) by using allen key (2), and bolt with spring washer & flat washer (1).

STEP 2: Attach headboard post left (B-L) and headboard post right (B-R) to headboard (A) by using allen key (2), and bolt with spring washer & flat washer (1)

ASSEMBLY INSTRUCTION

BOB'S SKU#: 20083157002/20083157001/20083157010

DESCRIPTION: KING HEADBOARD/FOOTBOARD/SIDE RAILS

Thank you for purchasing this quality product. Be sure to check all packing material carefully for small hardware which may have come loose inside the carton during shipment. Identify and count all hardware and compare with the hardware list below.

CAUTION: Do not attempt to move the bed when fully assembled. This could result in damage to the rails, headboard or footboard.

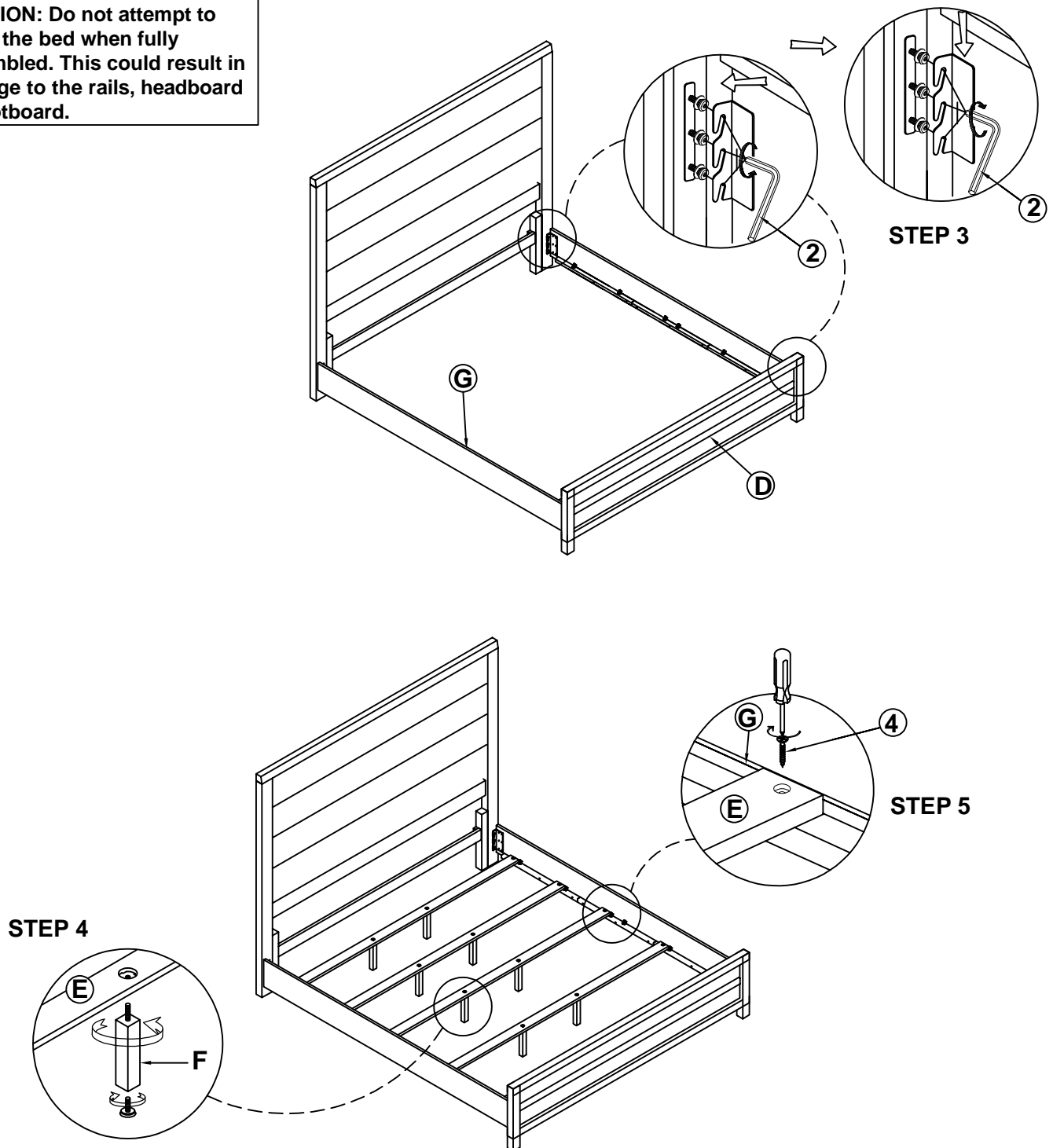

STEP 3: Attach side rails (G) to the headboard and footboard.

STEP 4: Attach slat support leg (F) to bed slats (E) by turning clockwise.

STEP 5: Please use a screwdriver (not provided in package) to attach bed slat (E) to side rails (G) by using screw (4).

 WARNING : To avoid serious personal injury :

- * Carefully and strictly follow assembly instructions. Improper assembly of furniture can result in structural failure, instability of the product, or tip-over.
- * Monitor and carefully control the assembly components. These include small parts and hardware that may present a choking hazard to small children. Bob's furniture should be assembled only by responsible adults and children should not be involved in the assembly process.
- * Where provided, wall mounting hardware should always be used as prescribed in these instructions to anchor furniture to walls. Proper use of the wall mounting hardware can significantly reduce the potential for furniture tip-over and crushing injuries.