





Assembly Instruction For 6-DRAWER DRESSER & MIRROR

200772B7009 / 200772B300B / 200B2941007

Caution : Please read instructions thoroughly before unpacking assembly parts. Sharp, exposed staple tips can cause injury, therefore, for your protection, please remove any exposed staples used in packing.

1. We recommend that you should assemble this product with the assistance of another person; this will make assembly easier, and will help to eliminate damage the product or injury to persons during assembly.
2. Be sure to check all packing materials carefully for small parts that may have come loose inside the carton during shipment.
3. Please do not over tighten screws or bolts.
4. Please put all parts on a non-abrasive floor before assembly, and follow the assembly steps to assemble your newly purchased product correctly and efficiently.

PART LIST			
NO.	PART DESC	Q'TY	
A	MIRROR	1	
B	SUPPORT SLATS	2	
C	DRESSER	1	

HARDWARE LIST			
NO.	HARDWARE DESC	CODE	Q'TY
1	 JCBC BOLT (1/4" x 40mm)	PB-2780-MRHW	8
2	 SPRING WASHER (1/4")		8
3	 FLAT WASHER (1/4"x 16mm)		8
4	 ALLEN KEY(4mm)		1
5	 SCREW-DRIVER(NOT PROVIDED)		

STEP 1

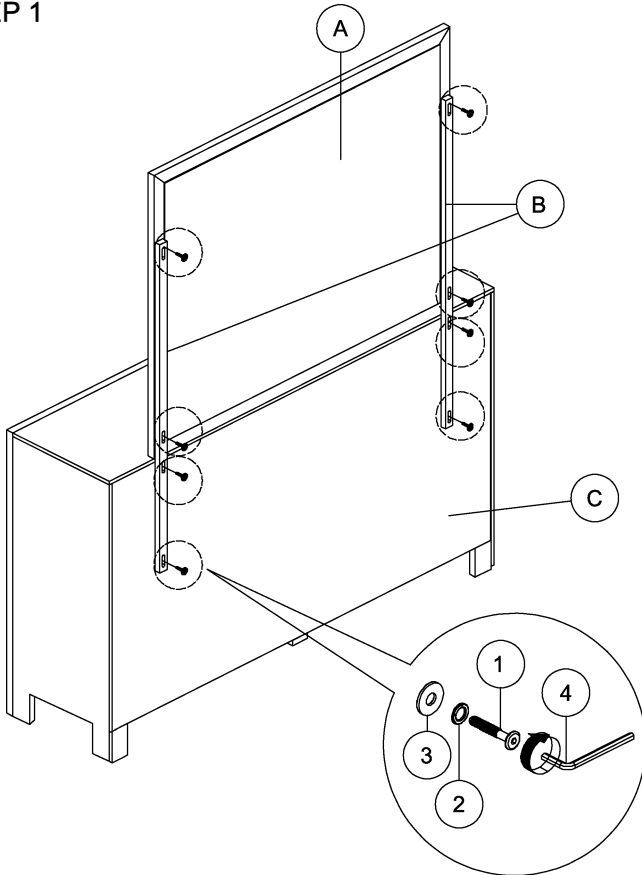

COMPLETED

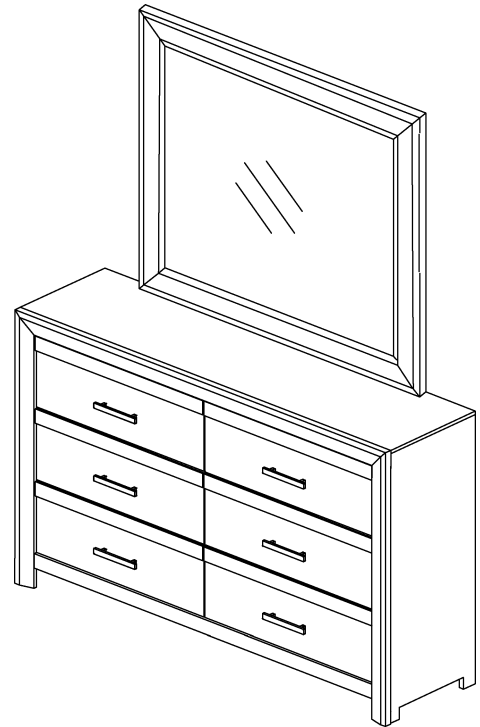

WARNING: To avoid serious personal injury:

- Carefully and strictly follow assembly instructions. Improper assembly of furniture can result in structural failure, instability of the product, or tip-over.
- Monitor and carefully control the assembly components. These include small parts and hardware that may present a choking hazard to small children. Furniture should be assembled only by responsible adults and children should not be involved in the assembly process.
- Where provided, wall mounting hardware should always be used as prescribed in these instructions to anchor furniture to wall. Proper use of the wall mounting hardware can significantly reduce the potential for furniture tip-over and crushing injuries.